



LPY SERIES

High and Ultra-High Energy Q-Switched Nd:YAG Lasers

2 0 1 9



LPY Series

Superior performance through superior design



The Evolution of the LPY Range

The LPY series of pulsed Nd:YAG lasers was designed to suit almost any industrial or research application requiring a high-energy or high-specification Nd:YAG laser. A 'no-compromise' design approach is evident in the build quality, a parameter that sets these lasers well apart from any of their competitors.

The modular design of the laser head allows a wide variety of resonator configurations and options to be offered, from single rod oscillators to fully birefringence compensating twin-rod-oscillator, twin-rod-amplifier systems. Furthermore, a choice of stable, stable-telescopic or graded reflectivity resonators is available, allowing the customer to specify a system that suits their requirements.



LPY Concept – Cost effective Customisation

The LPY Series is built on the industrial Invar space frame platform, which offers incredible stability. The modular nature of this design enables complete design customization to enable the customer to specify a laser system that is truly fit for purpose. The design also allows for easy maintenance when replacing consumable parts such as flashlamps that ensures minimal downtime.

Configurable features include

- Specification of cavity type i.e. stable, super-Gaussian, telescopic
- Cavity etalons to reduce the linewidth of the output
- Harmonic generation modules for 532, 355, 266 and 213nm
- Process shutters to ensure repeatable output energy from the first shot
- Sealed case to stop ingress of dust and dirt
- Complete software control with easy integration into proprietary software including LabView
- Bespoke conduit length

Litron Ultra-High Energy Lasers – Extending Outputs to 10J

In designing the Ultra-High Energy range of laser systems, Litron built on the already robust and reliable LPY platform. Many new features have evolved during the design of this range that complement the industry proven LPY designs offering Q-switched outputs up to 10J at 1064nm.

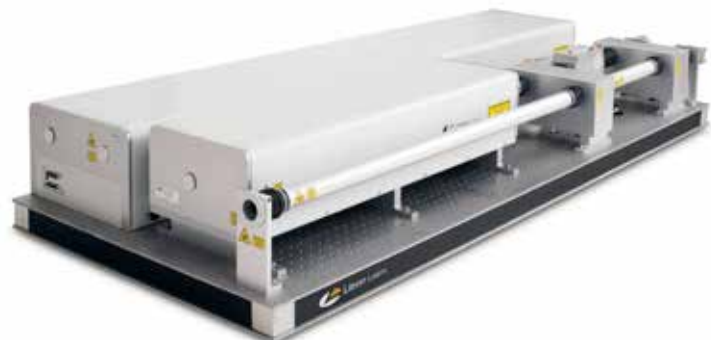

Advanced Features and Benefits Include

Full System Monitoring

All lasers feature a fully integrated control system that monitors many system parameters ensuring reliable operation. A comprehensive interlock suite coupled with touchscreen control and reporting ensure that the user is in full control of the laser and in full knowledge of its performance.



Remote Automation and Ease of Integration

With a host of interface options such as RS232, ethernet and CAN and a full software suite with necessary drivers and LabView integration the LPY series offer an unprecedented ease of use for both industrial systems integrators and researchers alike.

Motorised Harmonic Generation Stages

All harmonics are available with optional auto-tracking and auto-tuning. The system will automatically peak the output energy at startup or on request. Auto-tracking continuously seeks to maximise the output energy during operation whereas auto-tuning will maximise the output upon request.

Motorised Harmonic Separation and Switching

Motorised harmonic switching allows for remote switching between output wavelengths. When used in unison with the motorised harmonic generation and motorised mirror stages, each configurable wavelength can be selected and optimised remotely at the push of a button.



Integrated Injection Seeder

With the addition of an injection seeder output linewidths of 0.0016cm^{-1} are possible. The use of a high stability, high power SLM seed laser gives unsurpassed lock for continuous SLM output. Litron offers both true TEM_{00} and super-Gaussian-coupled resonator options with injection seeding.

Line Narrowing

Line narrowing etalons allow the linewidth of the laser output to be reduced for increased coherence length. In a stable resonator, the use of an output coupling etalon gives a linewidth of approximately 0.3cm^{-1} and an additional intra-cavity etalon will reduce the linewidth to approximately 0.06cm^{-1} . In a super-Gaussian-coupled resonator an intracavity etalon will reduce the linewidth to approximately 0.15cm^{-1} .

Variable Optical Attenuator

A variable optical attenuator is useful if the temporal profile of the pulse needs to be maintained at different output energies. The use of a half-wave plate and polariser allows continuous adjustment of the output energy with negligible effect on either the spatial or temporal pulse characteristics. Attenuators are available for both 1064nm and harmonic wavelengths.



Integrated Energy Monitor and Closed-loop Stabilisation.

A calibrated photodiode enables accurate energy monitoring of the output energy and optional closed-loop stabilisation of the laser and harmonic outputs.

Options for Systems Integrators

The inherent strength and stability of the LPY construction very easily lends itself to securely mounting beam handling solutions such as articulated arms or Galvo scanning heads.



LPY600/700 Series

High Energy Pulsed Nd:YAG Lasers

TECHNICAL DATA

Stable and Stable Telescopic Resonators - 10-20Hz Repetition Rate

Model	LPY704-10	LPY706-10	LPY664-10	LPY674-10	LPY764-10	LPY776-10	LPY787-10
Repetition Rate (Hz)	10	10	10	10	10	10	10
Output Energy (mJ)							
1064nm	420	650	850	1000	1250	1750	2000
532nm	210	325	425	500	675	700	750
355nm ⁽¹⁾	80	100	130	160	200	250	300
266nm	50	70	95	110	120	130	150
Pulse Stability (±%)							
1064nm	2	2	2	2	2	2	2
532nm	3	3	3	3	3	3	3
355nm	4	4	4	4	4	4	4
266nm	6	6	6	6	6	6	6
Parameter							
Beam Diameter (mm)	6.5	8	8	9.5	9.5	12.5	12.5
Beam Divergence (mrad) ⁽²⁾	<0.8	<0.8	<0.8	<0.8	<0.8	<0.8	<0.8
M ² @ 1064nm	<3.5	<3.5	<3.5	<3.5	<3.5	<3.5	<3.5
Pulse Length @1064nm (ns)	6-10	6-10	6-10	6-10	6-10	10-13	10-13
Pointing Stability (μrad) ⁽³⁾	<70	<70	<70	<70	<70	<70	<70
Lamp Life (pulses) ⁽⁴⁾	5x10 ⁷	5x10 ⁷	5x10 ⁷	5x10 ⁷	5x10 ⁷	5x10 ⁷	5x10 ⁷
Timing Jitter (ns) ⁽⁵⁾	<0.5	<0.5	<0.5	<0.5	<0.5	<0.5	<0.5
Services							
Voltage ⁽⁶⁾ (VAC)	220-250	220-250	220-250	220-250	220-250	220-250	220-250
Frequency ⁽⁷⁾ (Hz)	50 or 60	50 or 60	50 or 60	50 or 60	50 or 60	50 or 60	50 or 60
Power Phase	Single	Single ⁽⁸⁾	Single	Single	Single	Single	Single
Water Temp Max. (°C)	Air Cooled ⁽⁸⁾	Air Cooled ⁽⁸⁾	20	20	20	20	20
Inlet Pressure (bar)	n/a	n/a	2-5	2-5	2-5	2-5	2-5
PSU Type	LPU1000	LPU1000	16U Rackmount	16U Rackmount	16U Rackmount	16U Rackmount	16U Rackmount

Model	LPY704-20	LPY706-20	LPY664-20	LPY674-20	LPY764-20
Repetition Rate (Hz)	20	20	20	20	20
Output Energy (mJ)					
1064nm	380	600	800	850	1000
532nm	190	300	400	425	500
355nm ⁽¹⁾	70	85	110	130	140
266nm	35	65	75	80	90
Pulse Stability (±%)					
1064nm	2	2	2	2	2
532nm	3	3	3	3	3
355nm	4	4	4	4	4
266nm	6	6	6	6	6
Parameter					
Beam Diameter (mm)	6.5	8	8	9.5	8
Beam Divergence (mrad) ⁽²⁾	<0.8	<0.8	<0.8	<0.8	<0.8
M ² @ 1064nm	<3.5	<3.5	<3.5	<3.5	<3.5
Pulse Length @1064nm (ns)	6-10	6-10	6-10	6-10	6-10
Pointing Stability (μrad) ⁽³⁾	<70	<70	<70	<70	<70
Lamp Life (pulses) ⁽⁴⁾	5x10 ⁷	5x10 ⁷	5x10 ⁷	5x10 ⁷	5x10 ⁷
Timing Jitter (ns) ⁽⁵⁾	<0.5	<0.5	<0.5	<0.5	<0.5
Services					
Voltage ⁽⁶⁾ (VAC)	220-250	220-250	220-250	220-250	220-250
Frequency ⁽⁷⁾ (Hz)	50 or 60	50 or 60	50 or 60	50 or 60	50 or 60
Power Phase	Single	Single	Single	Single	Single
Water Temp Max. (°C)	Air Cooled ⁽⁸⁾	20	20	20	20
Inlet Pressure (bar)	n/a	2-5	2-5	2-5	2-5
PSU Type	LPU1000	16U Rackmount	16U Rackmount	16U Rackmount	16U Rackmount

- (1) Higher conversion efficiency into 3rd harmonic available using Type 1 doubler.
- (2) Full angle for 90% of the output energy.
- (3) Full angle.
- (4) Typical lifetime.
- (5) jitter is measured with respect to the Q-switch trigger input.
- (6) 110VAC option requires autotransformer to be specified on order.
- (7) 50 or 60Hz to be specified on order.
- (8) Ambient Temperature 5-35°C. (0-80% non condensing atmosphere.)

Stable and Stable Telescopic Resonators - 30-50Hz Repetition Rate

Model	LPY704-30	LPY706-30	LPY764-30	LPY774-30	LPY787-30	LPY704-50	LPY742-50
Repetition Rate (Hz)	30	30	30	30	30	50	50
Output Energy (mJ)							
1064nm	380	550	900	1200	1500	300	450
532nm	190	225	450	600	750	150	225
355nm ⁽¹⁾	50	80	150	200	250	40	80
266nm	45	60	80	100	120	20	35
Pulse Stability (±%)							
1064nm	2	2	2	2	2	2	2
532nm	3	3	3	3	3	3	3
355nm	4	4	4	4	4	4	4
266nm	6	6	6	6	6	6	6
Parameter							
Beam Diameter (mm)	6.5	8	8	9.5	12.5	6.5	6.5
Beam Divergence (mrad) ⁽²⁾	<0.8	<0.8	<0.8	<0.8	<0.8	<2.5	<2
Pulse Length @1064nm (ns)	8-10	8-10	8-10	8-10	8-10	8-10	8-10
Pointing Stability (μrad) ⁽³⁾	<70	<70	<70	<70	<70	<70	<70
Lamp Life (pulses) ⁽⁴⁾	5x10 ⁷	5x10 ⁷	5x10 ⁷	5x10 ⁷	5x10 ⁷	1.5x10 ⁸	1.5x10 ⁸
Timing Jitter (ns) ⁽⁵⁾	<0.5	<0.5	<0.5	<0.5	<0.5	<0.5	<0.5
Services							
Voltage ⁽⁶⁾ (VAC)	220-250	220-250	220-250	220-250	220-250	220-250	220-250
Frequency ⁽⁷⁾ (Hz)	50 or 60	50 or 60	50 or 60	50 or 60	50 or 60	50 or 60	50 or 60
Power Phase	Single	Single	Single	Single	Single	Single	Single
Water Temp Max. (°C)	20	20	20	20	20	20	20
Inlet Pressure (bar)	2-5	2-5	2-5	2-5	2-5	2-5	2-5
PSU Type	16U Rackmount	16U Rackmount	16U Rackmount	16U Rackmount	16U Rackmount	16U Rackmount	16U Rackmount

All LPY700 series systems feature a birefringence compensating twin rod oscillator design. The LPY600 series are single rod oscillator/oscillator-amplifiers.

LPY600 Stable Telescopic Resonators with TEM₀₀ Output

Model	LPY604T-10	LPY604T-20	LPY642T-10	LPY642T-20	LPY642T-30
	True TEM₀₀ Output				
Repetition Rate (Hz)	10	20	10	20	30
Output Energy (mJ)					
1064nm	80	70	350	300	250
532nm	40	35	175	150	125
355nm ⁽¹⁾	20	15	80	70	65
266nm	15	10	40	30	25
Pulse Stability (±%)					
1064nm	2	2	2	2	2
532nm	3	3	3	3	3
355nm	4	4	4	4	4
266nm	6	6	6	6	6
Parameter					
Beam Diameter (mm)	6.5	6.5	6.5	6.5	6.5
Beam Divergence (mrad) ⁽²⁾	<0.8	<0.8	<0.8	<0.8	<0.8
M ² @ 1064nm	<1.3	<1.3	<1.3	<1.3	<1.3
Pulse Length @1064nm (ns)	6-10	6-10	6-10	6-10	6-10
Pointing Stability (μrad) ⁽³⁾	<70	<70	<70	<70	<70
Lamp Life (pulses) ⁽⁴⁾	>10 ⁷	>10 ⁷	>10 ⁷	>10 ⁷	>10 ⁷
Timing Jitter (ns) ⁽⁵⁾	<0.5	<0.5	<0.5	<0.5	<0.5
Services					
Voltage ⁽⁶⁾ (VAC)	220-250	220-250	220-250	220-250	220-250
Frequency ⁽⁷⁾ (Hz)	50 or 60	50 or 60	50 or 60	50 or 60	50 or 60
Power Phase	Single	Single	Single	Single	Single
Water Temp Max. (°C)	20	20	20	20	20
Inlet Pressure (bar)	2-5	2-5	2-5	2-5	2-5
PSU Type	16U Rackmount	16U Rackmount	16U Rackmount	16U Rackmount	16U Rackmount

(1) Higher conversion efficiency into 3rd harmonic available using Type 1 doubler.

(2) Full angle for 90% of the output energy.

(3) Full angle.

(4) Typical lifetime.

(5) Jitter is measured with respect to the Q-switch trigger input.

(6) 110VAC option requires autotransformer to be specified on order.

(7) 50 or 60Hz to be specified on order.

Stable Resonators - 100-200Hz Repetition Rate

Model	LPY702-100	LPY704-100	LPY742-100	LPY702-150	LPY742-150	LPY702-200	LPY742-200
Repetition Rate (Hz)	100	100	100	150	150	200	200
Output Energy (mJ)							
1064nm	100	230	400	90	280	70	200
532nm	50	115	200	45	140	35	100
355nm ⁽¹⁾	20	20	70	12	30	10	30
266nm	10	15	20	7	18	6	10
Pulse Stability (±%)							
1064nm	2	2	2	2	2	2	2
532nm	3	3	3	3	3	3	3
355nm	4	4	4	4	4	4	4
266nm	6	6	6	6	6	6	6
Parameter							
Beam Diameter (mm)	4	6.5	6.5	5	5	4	6.5
Beam Divergence (mrad) ⁽²⁾	<5	<5	<5	<5	<5	<5	<5
Pulse Length @1064nm (ns)	10-12	11-18	10-12	10-15	10-15	10-15	10-15
Pointing Stability (μrad) ⁽³⁾	<100	<100	<100	<100	<100	<100	<100
Lamp Life (pulses) ⁽⁴⁾	1.5x10 ⁸	1.5x10 ⁸	1.5x10 ⁸	1.5x10 ⁸	1.5x10 ⁸	1.5x10 ⁸	1.5x10 ⁸
Timing Jitter (ns) ⁽⁵⁾	<0.5	<0.5	<0.5	<0.5	<0.5	<0.5	<0.5
Services							
Voltage ⁽⁶⁾ (VAC)	220-250	220-250	220-250	220-250	220-250	220-250	220-250
Frequency ⁽⁷⁾ (Hz)	50 or 60	50 or 60	50 or 60	50 or 60	50 or 60	50 or 60	50 or 60
Power Phase	Single	Single	Single	Single	Single	Single	Single
Water Temp Max. (°C)	20	20	20	20	20	20	20
Inlet Pressure (bar)	2-5	2-5	2-5	2-5	2-5	2-5	2-5
PSU Type	16U Rackmount	16U Rackmount	16U Rackmount	16U Rackmount	16U Rackmount	16U Rackmount	16U Rackmount

All LPY700 series systems feature a birefringence compensating twin rod oscillator design. The LPY600 series are single rod oscillator/oscillator-amplifiers.

Super-Gaussian Resonators - 10Hz Repetition Rate

Model	LPY704G-10	LPY 706G-10	LPY707G-10	LPY674G-10	LPY764G-10	LPY776G-10	LPY787G-10
Repetition Rate (Hz)	10	10	10	10	10	10	10
Output Energy (mJ)							
1064nm	400	650	850	1000	1250	1600	2000
532nm	200	325	435	500	675	820	1000
355nm ⁽¹⁾	80	110	150/230	250	225	320/490	400
266nm	50	70	105	110	125	160	195
Pulse Stability (±%)							
1064nm	<2	<2	<2	<2	<2	<2	<2
532nm	<4	<4	<4	<4	<4	<4	<4
355nm	<6	<6	<6	<6	<6	<6	<6
266nm	<8	<8	<8	<8	<8	<8	<8
Parameter							
Beam Diameter (mm)	6.5	8	9.5	9.5	9.5	12.5	12.5
Beam Divergence (mrad) ⁽²⁾	<0.5	<0.5	<0.5	<0.5	<0.5	<0.5	<0.5
M ² @ 1064nm	<2	<2	<2	<2	<2	<2	<2
Pulse Length @1064nm (ns)	6-9	6-9	6-9	6-9	6-9	6-9	6-9
Pointing Stability (μrad) ⁽³⁾	<50	<50	<50	<50	<50	<50	<50
Lamp Life (pulses) ⁽⁴⁾	>5x10 ⁷	>5x10 ⁷	>3x10 ⁷	>3x10 ⁷	>3x10 ⁷	>3x10 ⁷	>3x10 ⁷
Timing Jitter (ns) ⁽⁵⁾	<0.5	<0.5	<0.5	<0.5	<0.5	<0.5	<0.5
Services							
Voltage ⁽⁶⁾ (VAC)	220-250	220-250	220-250	220-250	220-250	220-250	220-250
Frequency ⁽⁷⁾ (Hz)	47-63	47-63	47-63	50 or 60	50 or 60	50 or 60	50 or 60
Power Phase	Single	Single	Single	Single	Single	Single	Single
Water Temp Max. (°C)	Air Cooled ⁽⁸⁾	Air Cooled ⁽⁸⁾	Air Cooled ⁽⁸⁾	20	20	20	20
Inlet Pressure (bar)	n/a	n/a	n/a	2-5	2-5	2-5	2-5
PSU Type	LPU1000	LPU1000	LPU1000	16U Rackmount	16U Rackmount	16U Rackmount	16U Rackmount

Super-Gaussian Resonators - 20Hz Repetition Rate

Model	LPY704G-20	LPY706G-20	LPY707G-20	LPY674G-20	LPY764G-20	LPY776G-20	LPY787G-20
Repetition Rate (Hz)	20	20	20	20	20	20	20
Output Energy (mJ)							
1064nm	380	600	800	850	1000	1400	1800
532nm	190	300	400	425	500	700	900
355nm ⁽¹⁾	70	90	130	150	140	280	380
266nm	45	65	75	80	90	140	180
Pulse Stability (±%)							
1064nm	<2	<2	<2	<2	<2	<2	<2
532nm	<4	<4	<4	<4	<4	<4	<4
355nm	<6	<6	<6	<6	<6	<6	<6
266nm	<8	<8	<8	<8	<8	<8	<8
Parameter							
Beam Diameter (mm)	6.5	8	9.5	9.5	9.5	12.5	12.5
Beam Divergence (mrad) ⁽²⁾	<0.5	<0.5	<0.5	<0.5	<0.5	<0.5	<0.5
M ² @ 1064nm	<2	<2	<2	<2	<2	<2	<2
Pulse Length @1064nm (ns)	6-9	6-9	6-9	6-9	6-9	6-9	6-9
Pointing Stability (μrad) ⁽³⁾	<50	<50	<50	<50	<50	<50	<50
Lamp Life (pulses) ⁽⁴⁾	>5x10 ⁷	>5x10 ⁷	>3x10 ⁷	>3x10 ⁷	>3x10 ⁷	>3x10 ⁷	>3x10 ⁷
Timing Jitter (ns) ⁽⁵⁾	<0.5	<0.5	<0.5	<0.5	<0.5	<0.5	<0.5
Services							
Voltage ⁽⁶⁾ (VAC)	220-250	220-250	220-250	220-250	220-250	220-250	220-250
Frequency ⁽⁷⁾ (Hz)	50 or 60	50 or 60	50 or 60	50 or 60	50 or 60	50 or 60	50 or 60
Power Phase	Single	Single	Single	Single	Single	Single	Single
Water Temp Max. (°C)	Air Cooled ⁽⁸⁾	20	20	20	20	20	20
Inlet Pressure (bar)	n/a	2-5	2-5	2-5	2-5	2-5	2-5
PSU Type	LPU1000	16U Rackmount	16U Rackmount	16U Rackmount	16U Rackmount	16U Rackmount	16U Rackmount

All LPY700 series systems feature a birefringence compensating twin rod oscillator design. The LPY600 series are single rod oscillator/oscillator-amplifiers.

Super-Gaussian Resonators - 30Hz Repetition Rate

Model	LPY704G-30	LPY706G-30	LPY764G-30	LPY774G-30	LPY787G-30	
Repetition Rate (Hz)	30	30	30	30	30	
Output Energy (mJ)						
1064nm	380	550	900	1200	1500	(1) Higher conversion efficiency into 3rd harmonic available using Type 1 doubler.
532nm	190	225	450	600	750	(2) Full angle for 90% of the output energy.
355nm ⁽¹⁾	50	80	150	260	300	(3) Full angle.
266nm	45	60	80	120	150	(4) Typical lifetime.
Pulse Stability (±%)						(5) Jitter is measured with respect to the Q-switch trigger input.
1064nm	<2	<2	<2	<2	<2	(6) 110VAC option requires autotransformer to be specified on order.
532nm	<4	<4	<4	<4	<4	(7) 50 or 60Hz to be specified on order.
355nm	<6	<6	<6	<6	<6	(8) Ambient Temperature 5-35°C. (0-80% non condensing atmosphere.)
266nm	<10	<10	<10	<10	<10	
Parameter						
Beam Diameter (mm)	6.5	8	9.5	9.5	12.5	
Beam Divergence (mrad) ⁽²⁾	<0.5	<0.5	<0.5	<0.5	<0.5	
M ² @ 1064nm	<2	<2	<2	<2	<2	
Pulse Length @1064nm (ns)	6-9	6-9	6-9	6-9	6-9	
Pointing Stability (μrad) ⁽³⁾	<50	<50	<50	<50	<50	
Lamp Life (pulses) ⁽⁴⁾	>3x10 ⁷	>3x10 ⁷	>3x10 ⁷	>3x10 ⁷	>3x10 ⁷	
Timing Jitter (ns) ⁽⁵⁾	<0.5	<0.5	<0.5	<0.5	<0.5	
Services						
Voltage ⁽⁶⁾ (VAC)	220-250	220-250	220-250	220-250	220-250	
Frequency ⁽⁷⁾ (Hz)	50 or 60	50 or 60	50 or 60	50 or 60	50 or 60	
Power Phase	Single	Single	Single	Single	Single	
Water Temp Max. (°C)	Air Cooled ⁽⁸⁾	20	20	20	20	
Inlet Pressure (bar)	n/a	2-5	2-5	2-5	2-5	
PSU Type	LPU1000	16U Rackmount	16U Rackmount	16U Rackmount	16U Rackmount	

LPY7000 Series

High Energy Pulsed Nd:YAG Lasers

The **LPY7000** lasers offer extremely high energy Q-switched outputs up to 3.5J and repetition rates of up to 50Hz. Based around Litron's proven self-supporting Invar frame, the robust build quality is suitable for both industrial and scientific applications. Energies up to 10J are also available at 1064nm with extra amplification.

The lasers are provided in an oscillator, pre-amplifier, main-amplifier arrangement. The oscillator may be configured as a stable-telescopic resonator offering a low order multimode output with a smooth spatial and temporal profile, or as an unstable super-Gaussian-coupled resonator offering a single transverse mode output with slightly higher peak powers.

Lamp change is performed in a matter of minutes with no need for any re-alignment. An optional IP54 sealed case ensures that the laser is protected against the ingress of dirt and moisture when used in industrial environments.

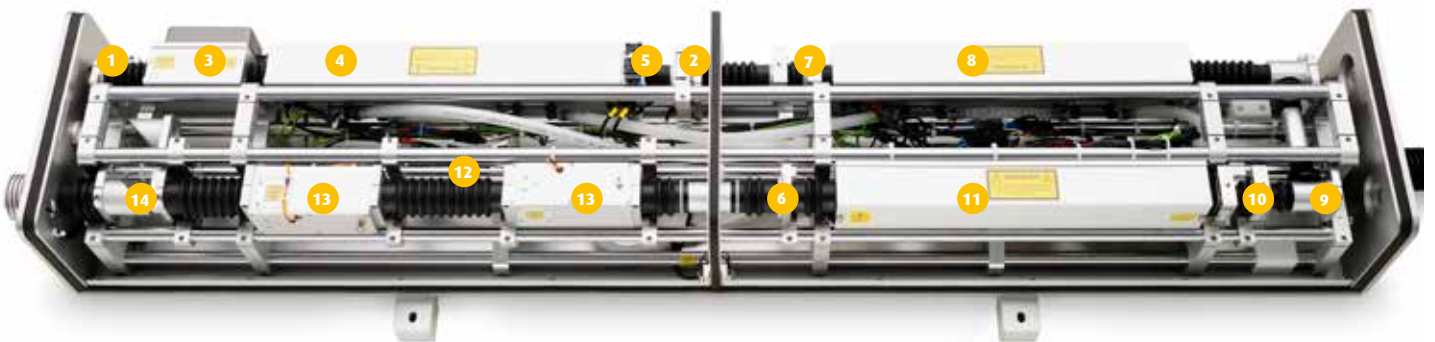

1 Rear Mirror

2 Output Coupler

3 Electro-optic Q-Switch

A KD*P Pockels cell is used within the Q-switch assembly.

4 Oscillator Pump Chamber

All pump chambers are machined from solid 316 stainless steel. The chambers are split such that the lamp housing can be removed easily during lamp changes, leaving the rod untouched. The chambers are fitted with close coupled ceramic reflectors for efficient and uniform pumping.

A proprietary filter plate protects the laser rod from UV emission from the lamp and also in the event of a lamp failure. The design of the chambers is such that a large turbulent water flow leads to very uniform cooling of the rod, essential for good pointing and overall stability.

5 Intra-cavity Shutter

An electronically verified, electronically actuated, intra-cavity safety shutter is standard on all of Litron's lasers.

6 Waveplate

7 Expanding Telescope

An expanding telescope is used to expand and collimate the oscillator output prior to amplification.

8 Pre-amplifier Pump Chamber

9 Steering Mirrors

10 Expanding Telescope

11 Main Amplifier Pump Chambers

The main amplifier is configured in a birefringence-compensated twin-rod topology. This minimises the depolarisation of the laser beam and leads to more uniform and more efficient harmonic generation.

12 Invar Rail

The lasers are built on a rugged self-supporting Invar rail. This feature sets them apart from all competitors as it is both more robust and more stable than conventional base-plate constructions. The modular nature of the rail allows for easy customisation of the lasers.

13 Harmonic Generation Unit

14 Output Steering Mirrors

TECHNICAL DATA

Super-Gaussian Resonators

Model	LPY7864-10	LPY7864-20	LPY7864-30	LPY7864-50	LPY7875-10	LPY7875-20
Repetition Rate (Hz)	10	20	30	50	10	20
Output Energy (mJ)						
1064nm	2750	2250	2000	1400	3500	2750
532nm	1400	1100	1000	700	1750	1350
355nm	600	480	450	250	700	600
266nm	250	140	95	80	275	170
Pulse Stability (±%)						
1064nm	2	2	2	2	2	2
532nm	4	4	4	4	4	4
355nm	6	6	6	6	6	6
266nm	8	8	8	8	8	8
Parameter						
Beam Diameter (mm) ⁽¹⁾	12.5	12.5	12.5	12.5	15	15
Beam Divergence (mrad) ⁽²⁾	<0.5	<0.5	<0.5	<0.5	<0.5	<0.5
Pulse Length @1064nm (ns)	10-12	10-12	10-12	10-12	10-12	10-12
Pointing Stability (μrad) ⁽³⁾	50	50	50	50	50	50
Timing Jitter (ns) ⁽⁴⁾	<0.5	<0.5	<0.5	<0.5	<0.5	<0.5
Services						
Voltage (VAC)	220-250	220-250	220-250	220-250	220-250	220-250
Frequency (Hz)	50 or 60	50 or 60	50 or 60	50 or 60	50 or 60	50 or 60
Power Phase	Single	Single	Single	Single	Single	Single

(1) Quoted as the main amplifier rod diameter.

(2) Full angle for 90% of the energy.

(3) Full angle.

(4) Jitter is measured with respect to the external Q-switch trigger input.

Stable Telescopic Resonators

Model	LPY7864-10	LPY7864-20	LPY7864-30	LPY7864-50	LPY7875-10	LPY7875-20
Repetition Rate (Hz)	10	20	30	50	10	20
Output Energy (mJ)						
1064nm	2750	2250	2000	1400	3500	2750
532nm	1400	1100	1000	700	1750	1350
355nm	385	315	280	195	490	385
266nm	280	220	200	140	350	270
Pulse Stability (±%)						
1064nm	2	2	2	2	2	2
532nm	4	4	4	4	4	4
355nm	6	6	6	6	6	6
266nm	8	8	8	8	8	8
Parameter						
Beam Diameter (mm) ⁽¹⁾	12.5	12.5	12.5	12.5	15	15
Beam Divergence (mrad) ⁽²⁾	<0.8	<0.8	<0.8	<0.8	<0.8	<0.8
Pulse Length @1064nm (ns)	12-15	12-15	12-15	12-15	12-15	12-15
Pointing Stability (μrad) ⁽³⁾	100	100	100	100	100	100
Timing Jitter (ns) ⁽⁴⁾	<0.5	<0.5	<0.5	<0.5	<0.5	<0.5
Services						
Voltage (VAC)	220-250	220-250	220-250	220-250	220-250	220-250
Frequency (Hz)	50 or 60	50 or 60	50 or 60	50 or 60	50 or 60	50 or 60
Power Phase	Single	Single	Single	Single	Single	Single

(1) Quoted as the main amplifier rod diameter.

(2) Full angle for 90% of the energy.

(3) Full angle.

(4) Jitter is measured with respect to the external Q-switch trigger input.

LPY10J Series

Ultra-High Energy Pulsed Nd:YAG Lasers



The LPY10J laser systems offer Q-switched output energies of 10J at 1064nm from a proven design platform. The self-supporting Invar frame has been utilised for many years in industrial and scientific applications where robustness and stability are paramount.

In addition to the standard configuration, there are several options available: injection seeder to provide a narrow linewidth; harmonic generation units to provide outputs up to the 4th harmonic; automated wavelength selection; energy monitoring; automatic output peaking and continuous tracking.

SYSTEM CONFIGURATION

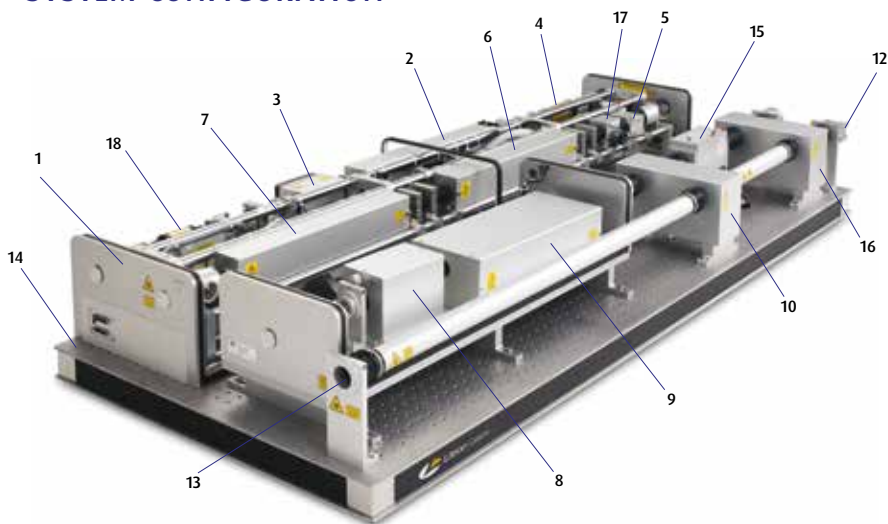

1. Invar stabilised optical rail using 8 bar self supporting format.
2. Twin rod, birefringence compensating oscillator.
3. Q-switch assembly.
4. Faraday isolator.
5. Motorised Attenuator.
6. Twin rod, birefringence compensating pre-amplifier.
7. Twin rod, birefringence compensating amplifier.
8. Beam expanding telescope.
9. Power amplifier stage.
10. Beam switching unit for 1064nm only output.
11. Connections for power supply umbilicals.
12. Laser diode pointer assembly.
13. Laser output port.
14. Optical breadboard.

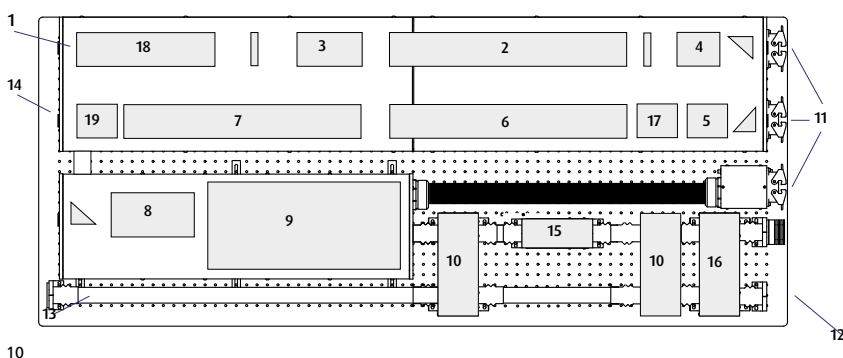

Optional accessories

15. Motorised second harmonic generation assembly.
16. Second harmonic separation assembly.
17. Beam dump shutter assembly.
18. Injection Seeder assembly.
19. Beam switching assembly (optional).

TECHNICAL DATA

Model	LPYG 10J-1	LPYG 10J-5	LPYST 10J-1	LPYST 10J-5
Repetition Rate (Hz)	1	5	1	5
Output Energy (J) ^(1a)				
1064nm	10	10	10	10
532nm	5	5	5	5
355nm ^(1b)	2.5	2.5	2.5	2.3
266nm	0.8	0.8	0.8	0.5
Pulse Stability ($\pm\%$) ⁽²⁾				
1064nm	<2	<2	<2	<2
532nm	<4	<4	<4	<4
355nm	<6	<6	<6	<6
266nm	<10	<10	<10	<10
Pulse Length (ns) ⁽³⁾				
1064nm	7-11	7-11	20-22	20-22
532nm	7-11	7-11	20-22	20-22
355nm	6-10	6-10	19-21	19-21
266nm	5-9	5-9	18-20	18-20
Parameter				
System configuration	Osc/Amp	Osc/Amp	Osc/Amp	Osc/Amp
Oscillator configuration	Gaussian	Gaussian	Stable/Tel	Stable/Tel
Beam diameter (mm)	25	25	25	25
Beam divergence (mrad) ⁽⁴⁾	<0.5	<0.5	<0.8	<0.8
M ²	<2	<2	<10	<10
Linewidth @ 1064nm (cm ⁻¹)	<1	<1	<1	<1
Linewidth Seeded	0.003	0.003	n/a	n/a
Pointing stability (μ rad) ⁽⁵⁾	± 100	± 100	± 100	± 100
Lamp life (pulses) ⁽⁶⁾	1.5×10^8	1.5×10^8	1.5×10^8	1.5×10^8
Timing jitter (ns) ⁽⁷⁾	<0.5	<0.5	<0.5	<0.5
Services				
Voltage (VAC) ⁽⁸⁾	220-250	220-250	220-250	220-250
Phases	Single	Single	Single	Single
Frequency (Hz) ⁽⁹⁾	50 or 60	50 or 60	50 or 60	50 or 60
Operating ambient temp (°C)	5-30	5-30	5-30	5-30
Laser cooling	Water	Water	Water	Water
PSU type	19" Rack	19" Rack	19" Rack	19" Rack

- (1a) Single wavelength output only.
- (1b) Dedicated 355nm only laser model.
- (2) Peak to peak energy - 100% of pulses.
- (3) FWHM.
- (4) Full angle for 90% of the output energy.
- (5) Full angle.
- (6) Typical lifetime.
- (7) RMS jitter, measured with respect to the Q-switch trigger input.
- (8) 208VAC option requires autotransformer to be specified on order.
- (9) 50 or 60Hz to be specified on order.

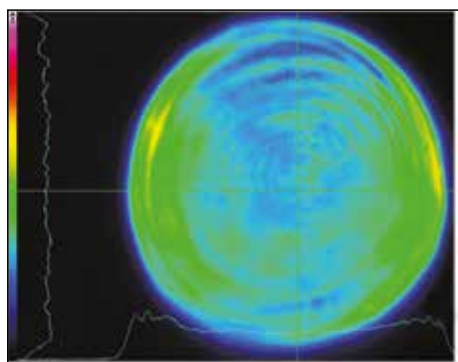

Telescopic stable beam profile at 5J, 532nm, 5Hz

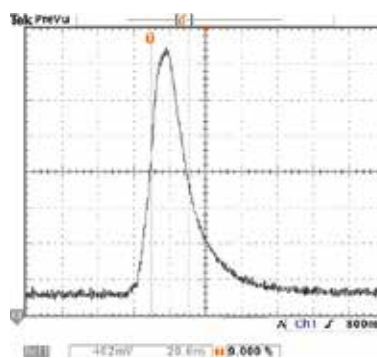

Pulsewidth at 5J, 532nm, 5Hz. 20ns FWHM.

MECHANICAL DATA

LPY600/700

All dimensions shown in mm

Single Rail Laser Head Arrangement

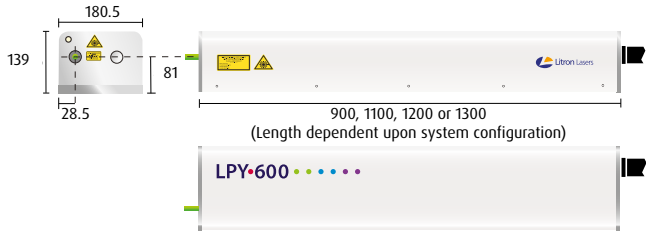

Twin Rail Laser Head Arrangement

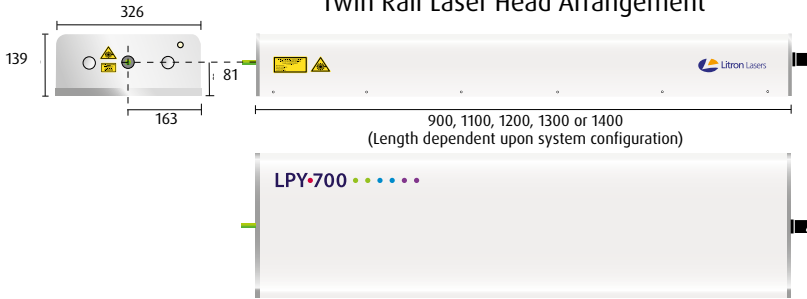

16U Rackmount PSU

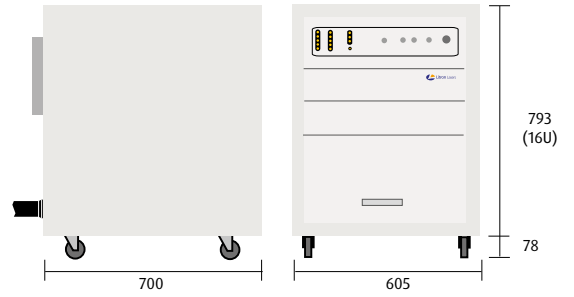

LPU1000 PSU

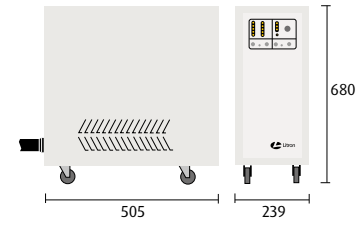

LPY7000

All dimensions shown in mm

Laser Head Unit

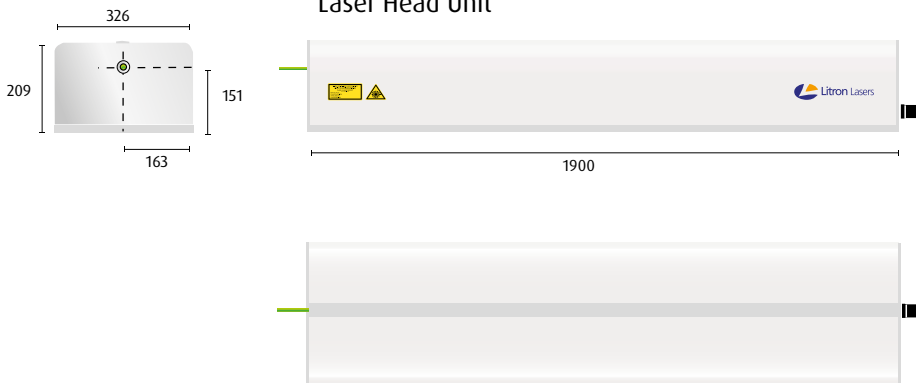

Rackmount PSU

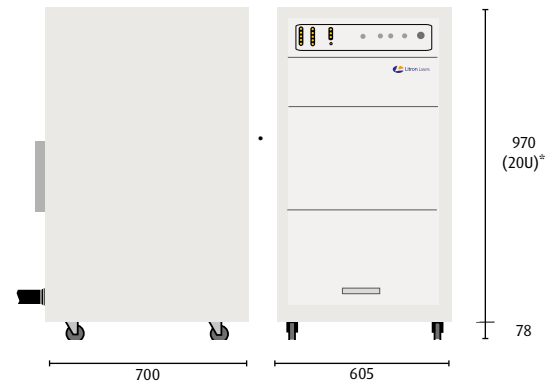

* Extra 4U dependent on system configuration.

LPY10J

All dimensions shown in mm

Laser Head Unit

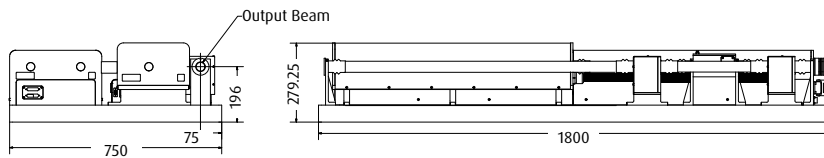

Power Supply Unit

(2 units required for this system)

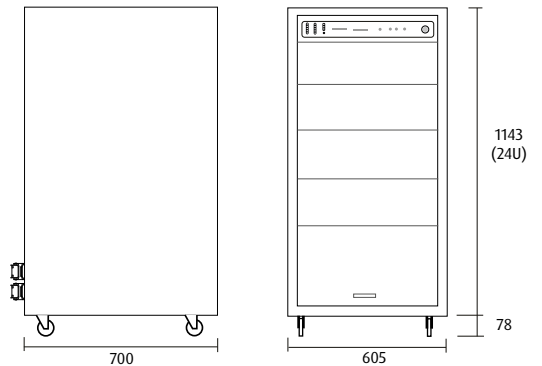

Our policy is to improve the design and specification of our products. The details given in this document are not to be regarded as binding.



Litron Lasers Ltd
8 Consul Road, Rugby,
Warwickshire CV21 1PB
England.

T +44 (0)1788 574444
F +44 (0)1788 574888
E sales@litron.co.uk



www.litronlasers.com